



Residential Reference Guide

The one-stop guide from North America's largest roofing manufacturer



GAF shingles and roof accessories are made to work together. They provide a system that's built to protect homes—so the people who live inside them can enjoy what matters most.





We protect what matters most™

	LRS	Pages
Technology Index		3
GAF Lifetime [†] Roofing System LRS		4–5
GAF Shingles		6–19
Timberline[®] Lifetime[†] Shingles Collection LRS		
Timberline HDZ [®]	●	8
Timberline [®] UHDZ™	●	9
Timberline [®] NS	●	10
Timberline [®] CS	●	11
Designer Lifetime[†] Shingles[®] Collection LRS		
Grand Canyon [®]	●	13
Camelot [®] II	●	14
Grand Sequoia [®]	●	14
Woodland [®]	●	15
Slateline [®]	●	15
SBS Modified IR Shingles Collection LRS		
Timberline [®] AS II	●	16–17
Grand Sequoia [®] AS	●	16–17
3-Tab Shingle Collection (Excluded from LRS)		
Royal Sovereign [®]		18–19
Shingle Specifications Chart		20–21
GAF Roofing Accessories LRS		
Leak Barriers	●	23
Roof Deck Protection	●	24
Starter Strip Shingles	●	25
Cobra [®] Attic Ventilation	●	26
Ridge Cap Shingles	●	27
Other Products		
Master Flow [®] Ventilation Products		28
WeatherSide™ Fiber-Cement Siding		29
ThermaCal [®] Building Envelope Insulation Panels		30
LIBERTY™ Self-Adhering Roofing System		31



Trust the diamonds

Whether it's warranty coverage that gives homeowners peace of mind or technology that makes their roof look and perform its best, there's a GAF diamond badge behind it.

	Install any GAF Lifetime [†] Shingle and get a Lifetime[†] Limited Warranty on your qualifying shingle. Install any GAF Lifetime [†] Shingle and at least 3 qualifying GAF Accessories, and get a Lifetime[†] Limited Warranty on your qualifying GAF products.
	GAF Advanced Protection[®] Shingle Technology uses highly advanced design and manufacturing techniques to produce cutting-edge roofing products.
	Dura Grip[™] Adhesive helps protect your roof investment from winds and wind-driven rain.
	Comes with a 25-year StainGuard Plus[™] or 30-year StainGuard Plus PRO[™] (as indicated) Algae Protection Limited Warranty¹ against blue-green algae discoloration and GAF Time-Release Algae-Fighting Technology, which releases copper over time for long-lasting algae-fighting power.
	
	StainGuard[®] Algae Protection² is a 10-year limited warranty against blue-green algae discoloration.
	LayerLock[®] Technology is a proprietary technology which mechanically fuses the common bond between overlapping shingle layers.
	WindProven[™] Limited Wind Warranty³ is a 15-year limited wind warranty with no maximum wind speed limitation — available when you install the LayerLock [®] -labeled Shingles as well as GAF starter strips, roof deck protection, ridge cap shingles, and leak barrier or attic ventilation.
	25-Year Limited Warranty Term⁴ gives homeowners protection they can trust.
	Patent-pending Dual Shadow Line for sunset shadows all day long.

[†] Lifetime refers to the length of warranty coverage provided and means as long as the original individual owner(s) of a single-family detached residence [or eligible second owner(s)] owns the property where the qualifying GAF products are installed. For other owners/structures, Lifetime coverage is not applicable. Lifetime coverage on shingles requires the use of GAF Lifetime Shingles only. See the *GAF Shingle & Accessory Limited Warranty* for complete coverage and restrictions. Visit gaf.com/LRS for qualifying GAF products.

¹ The 25-year StainGuard Plus[™] or the 30-year StainGuard Plus PRO[™] Algae Protection Limited Warranty against blue-green algae discoloration is available only on products sold in packages bearing the appropriate StainGuard Plus[™] or StainGuard Plus Pro[™] logos. See *GAF Shingle & Accessory Limited Warranty* for complete coverage and restrictions, and qualifying products.

² 10-year StainGuard[®] Algae Protection Limited Warranty against blue-green algae discoloration is available only on products sold in packages bearing the StainGuard[®] logo. See *GAF Shingle & Accessory Limited Warranty* for complete coverage and restrictions, and qualifying products.

³ 15-year WindProven[™] limited wind warranty on GAF Shingles with LayerLock[®] Technology requires the use of GAF Starter Strips, Roof Deck Protection, Ridge Cap Shingles, and Leak Barrier or Attic Ventilation. See *GAF Roofing System Limited Warranty* for complete coverage and restrictions. Visit gaf.com/LRS for qualifying GAF products. For installations not eligible for the *GAF Roofing System Limited Warranty*, see the *GAF Shingle & Accessory Limited Warranty*.

⁴ See *GAF Shingle & Accessory Limited Warranty* for complete coverage and restrictions.

Trust the system that's built to protect

A roof is so much more than shingles. It's layers of protection, working together to help keep your home safe from wind, rain, snow, and even sun.

Install any GAF Lifetime⁺ Shingle and at least 3 qualifying GAF Accessories and get a Lifetime⁺ limited warranty on your qualifying GAF products plus non-prorated coverage for the first 10 years. For even stronger coverage, ask your GAF factory-certified contractor¹ about enhanced GAF warranties.

Visit gaf.com/LRS for a list of qualifying GAF products.

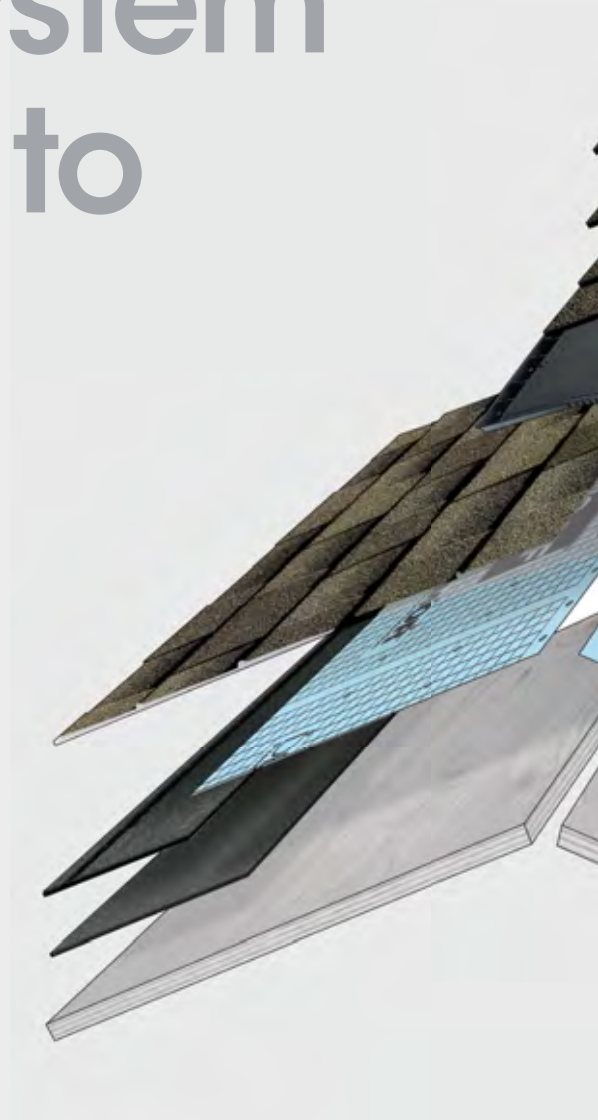

Visit gaf.com/Lifetime



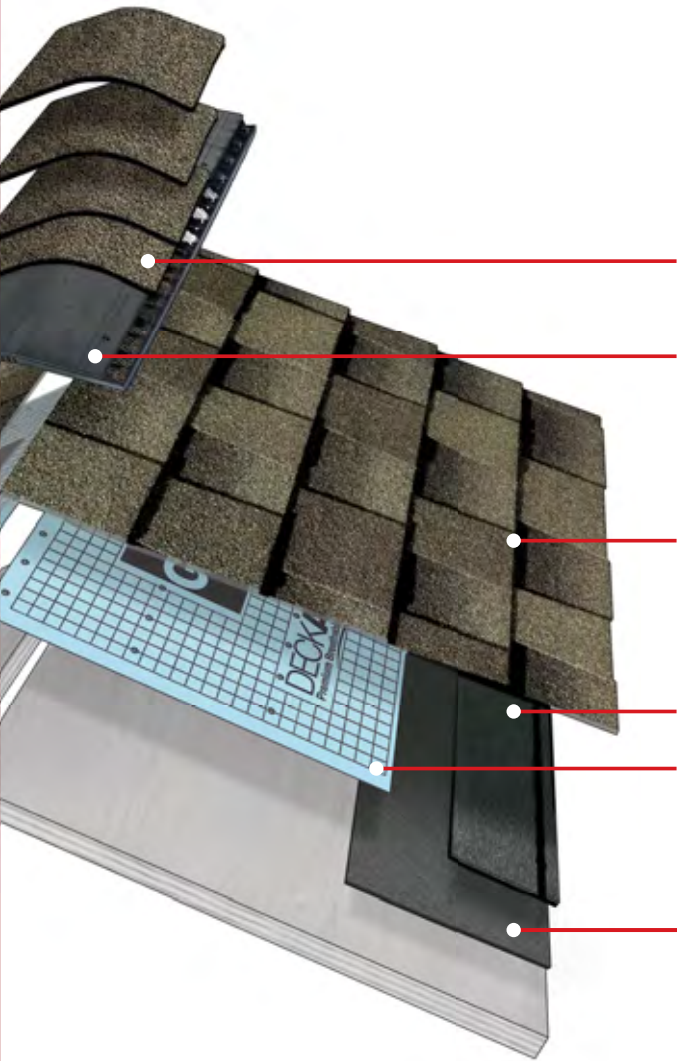

- Ridge Cap Shingles

- Cobra® Attic Ventilation

- Lifetime⁺ Shingles

- Starter Strip Shingles

- Roof Deck Protection

- Leak Barrier



[†]Lifetime refers to the length of warranty coverage provided and means as long as the original individual owner(s) of a single-family detached residence [or eligible second owner(s)] owns the property where the qualifying GAF products are installed. For other owners/structures, Lifetime coverage is not applicable. Lifetime coverage on shingles requires the use of GAF Lifetime Shingles only. See the *GAF Shingle & Accessory Limited Warranty* for complete coverage and restrictions. Visit gaf.com/LRS for qualifying GAF products. Lifetime coverage on shingles and accessories requires the use of any GAF Lifetime Shingle and at least 3 qualifying GAF Accessories. See the *GAF Roofing System Limited Warranty* for complete coverage and restrictions. For installations not eligible for the *GAF Roofing System Limited Warranty*, see the *GAF Shingle & Accessory Limited Warranty*. Visit gaf.com/LRS for qualifying GAF products.

[†]Contractors enrolled in GAF certification programs are not employees or agents of GAF, and GAF does not control or otherwise supervise these independent businesses. Contractors may receive benefits, such as loyalty rewards points and discounts on marketing tools from GAF for participating in the program and offering GAF enhanced warranties, which require the use of a minimum amount of GAF products.

Timberline® Lifetime[†] Shingles Collection

More homeowners in North America rely on Timberline® Shingles than any other brand. They offer just the right combination of beauty, performance, and reliability.

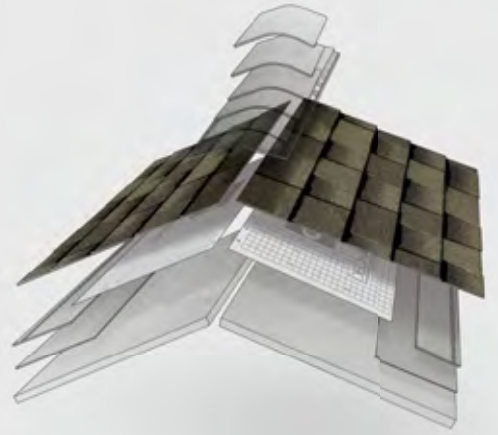

<p>Timberline HDZ®</p> <p>pg 7-8</p>			<p>America's #1-selling shingle—now featuring the industry's widest nail zone</p>
<p>Timberline UHDZ™</p> <p>pg 7 & 9</p>			<p>For a highly dimensional wood-shake look in an asphalt shingle</p>
<p>Timberline® NS</p> <p>pg 10</p>			<p>The beauty of natural wood shakes in an asphalt shingle</p>
<p>Timberline® CS</p> <p>pg 11</p>			<p>Our most reflective shingle</p>

For specifications see pages 20-21



For the full collection visit gaf.com/Timberline



[†] 15-year WindProven™ limited wind warranty on GAF Shingles with LayerLock® Technology requires the use of GAF Starter Strips, Roof Deck Protection, Ridge Cap Shingles, and Leak Barrier or Attic Ventilation. See GAF Roofing System Limited Warranty for complete coverage and restrictions. Visit gaf.com/LRS for qualifying GAF products. For installations not eligible for the GAF Roofing System Limited Warranty, see the GAF Shingle & Accessory Limited Warranty.

Color Availability

Timberline HDZ®

Most Popular Colors:

	1	2	3	4	5	6	7
Barkwood	•	•	•	•	•	•	•
Charcoal	•	•	•	•	•	•	•
Hickory	•	•	•	•	•	•	•
Hunter Green	•	•	•	•	•	•	•
Mission Brown	•	•	•	•	•	•	•
Pewter Gray	•	•	•	•	•	•	•
Shakewood	•	•	•	•	•	•	•
Slate	•	•	•	•	•	•	•
Weathered Wood	•	•	•	•	•	•	•

Harvest Blend Colors:

Appalachian Sky	•	•	•	•	•	•	•
Nantucket Morning	•	•	•	•	•	•	•
Golden Harvest	•	•	•	•	•	•	•
Cedar Falls	•	•	•	•	•	•	•

Regional Colors:

Biscayne Blue	•						
Birchwood ²		•		•	•	•	•
Copper Canyon ²					•		
Driftwood						•	•
Fox Hollow Gray	•	•					
Golden Amber ^{1,2}					•		
Oyster Gray	•					•	•
Patriot Red	•						
Sunset Brick						•	
White ²						•	
Williamsburg Slate	•	•					

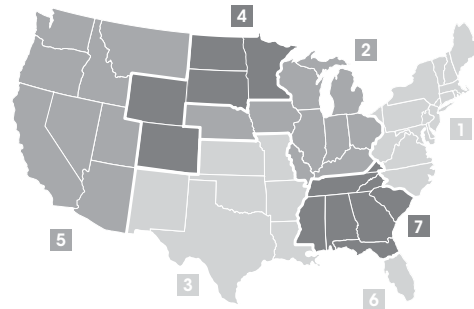

Timberline® UHDZ™

Most Popular Colors:

	1	2	3	4
Barkwood	•	•	•	•
Charcoal	•	•	•	•
Pewter Gray	•	•	•	•
Shakewood	•	•	•	•
Slate	•	•	•	•
Weathered Wood	•	•	•	•

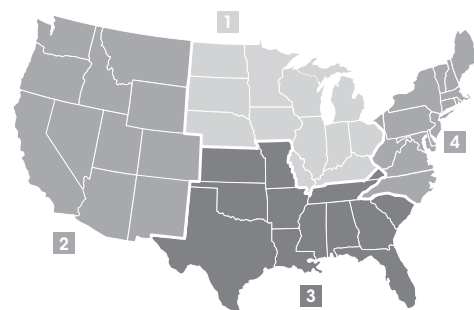

¹ Limited availability.

² Rated by the Cool Roof Rating Council (CRRCC) and can be used to comply with 2019 Title 24, Part 6, Cool Roof Requirements of the California Code of Regulations.

GAF **TimberlineHDZ[®]**
High Definition[®] Lifetime¹ Shingles



Now with GAF Time-Release Algae-Fighting Technology and LayerLock[®] Technology, Timberline HDZ[®] offers everything you can expect from an architectural shingle roof, and more.

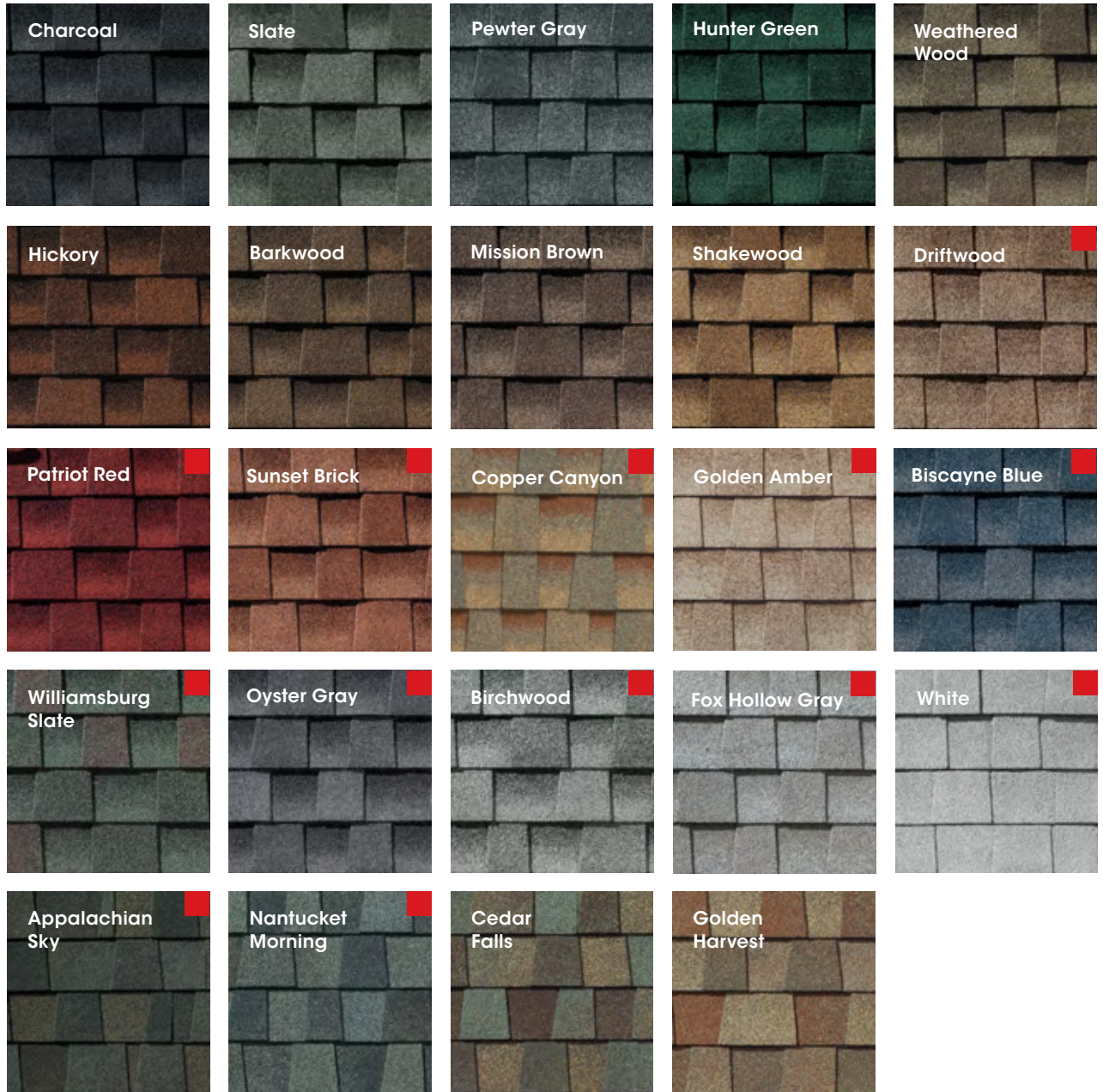

For more details visit gaf.com/TimberlineHDZ

¹ 15-year WindProven[™] limited wind warranty on GAF Shingles with LayerLock[®] Technology requires the use of GAF Starter Strips, Roof Deck Protection, Ridge Cap Shingles, and Leak Barrier or Attic Ventilation. See *GAF Roofing System Limited Warranty* for complete coverage and restrictions. Visit gaf.com/LRS for qualifying GAF products. For installations not eligible for the *GAF Roofing System Limited Warranty*, see the *GAF Shingle & Accessory Limited Warranty*.

GAF Timberline® UHDZ™
Ultra High Definition® Lifetime® Shingles



Crafted for homeowners ready to go beyond expectations, Timberline® UHDZ™ Shingles feature a Dual Shadow Line for dramatic sunset shadows and offer a 30-year StainGuard Plus PRO™ limited warranty against blue-green algae discoloration¹.

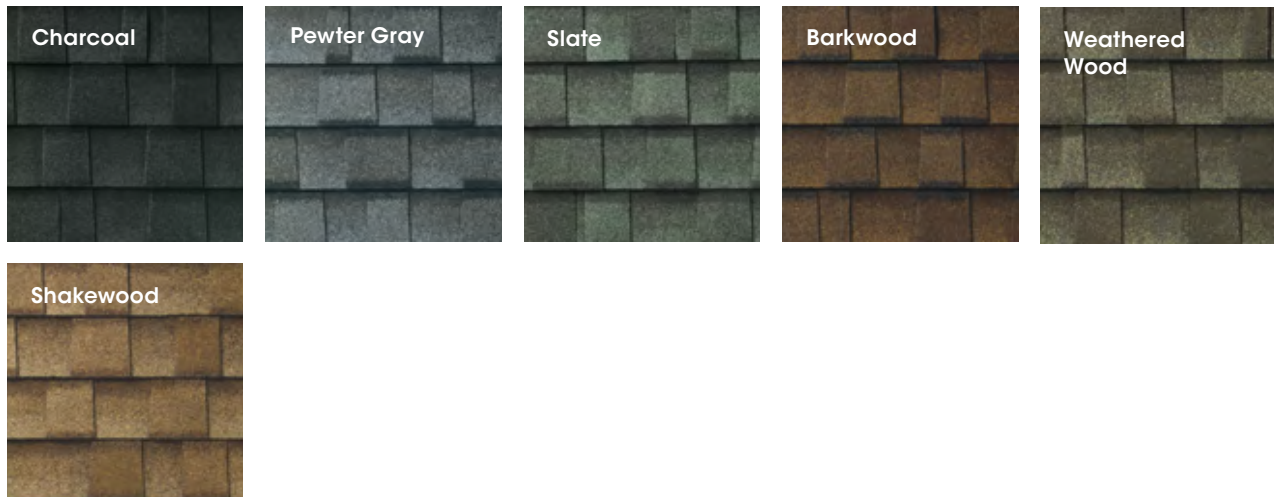

For more details visit gaf.com/uhdz

¹30-year StainGuard Plus PRO™ Algae Protection Limited Warranty against blue-green algae discoloration is available only on products sold in packages bearing the StainGuard Plus PRO™ logo. See GAF Shingle & Accessory Limited Warranty for complete coverage and restrictions, and qualifying products.

NOTE: It is difficult to reproduce the color clarity and actual color blends of these products. Before selecting your color, please ask to see several full-size shingles.



GAF **Timberline[®] NS**
Natural Shadow[®] Lifetime[†] Shingles

These stylish yet practically priced architectural shingles provide value and performance with a classic shadow effect for a subtle, even-toned look.

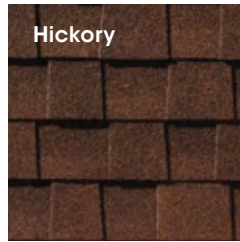
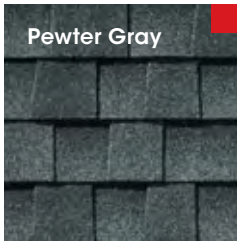
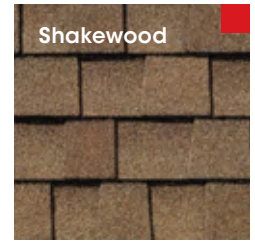
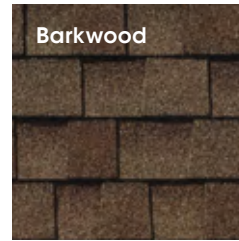
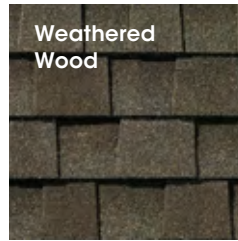
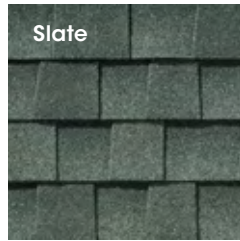
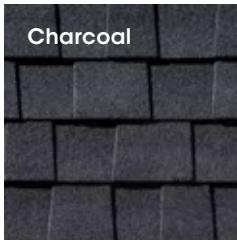

Timberline[®] Shingles LRS

For more details visit gaf.com/NS

GAF **Timberline® CS**
Cool Series® Lifetime[†] Shingles

Highly reflective shingles that can help to reduce temperatures in your attic, and help save on air-conditioning costs.²

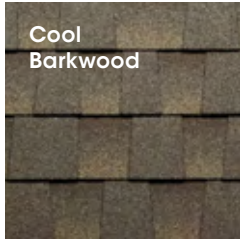
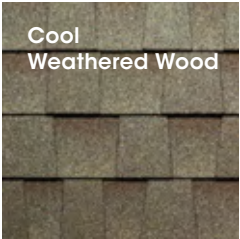

For more details visit gaf.com/CS

¹ 15-year WindProven™ limited wind warranty on GAF Shingles with LayerLock® Technology requires the use of GAF Starter Strips, Roof Deck Protection, Ridge Cap Shingles, and Leak Barrier or Attic Ventilation. See GAF Roofing System Limited Warranty for complete coverage and restrictions. Visit gaf.com/LRS for qualifying GAF products. For installations not eligible for the GAF Roofing System Limited Warranty, see the GAF Shingle & Accessory Limited Warranty.

² Energy cost savings are not guaranteed and the amount of savings may vary based on climate zone, utility rates, radiative properties of roofing products, insulation levels, HVAC equipment efficiency, and other factors.

NOTE: It is difficult to reproduce the color clarity and actual color blends of these products. Before selecting your color, please ask to see several full-size shingles.

Designer Lifetime[†] Shingles Collection

Sophisticated designs, custom color palettes, and high performance, GAF Lifetime[†] Designer Shingles are only a fraction of the cost of traditional slate or wood shakes.

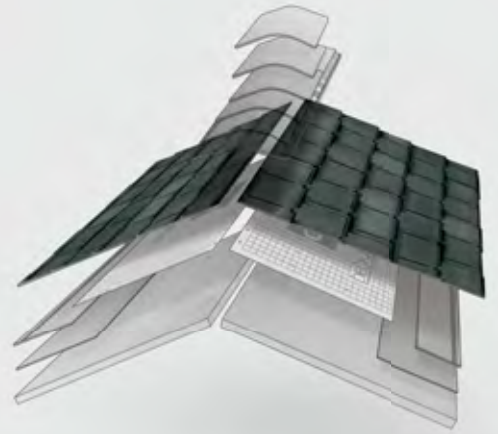

Designer Lifetime[†] Shingles Collection

<p>Grand Canyon[®] pg 13</p>			<p>Rugged sophistication with striking depth</p>
<p>Camelot II[®] pg 14</p>			<p>Contemporary slate-inspired elegance in an asphalt shingle</p>
<p>Grand Sequoia[®] pg 14</p>			<p>Rustic charm meets 21st-century style</p>
<p>Woodland[®] pg 15</p>			<p>The beauty of natural wood shakes in an asphalt shingle</p>
<p>Slateline[®] pg 15</p>			<p>An asphalt shingle with the dramatic look of slate</p>

For specifications see pages 20-21



For the full collection visit gaf.com/Designer



GAF GrandCanyon®

Designer Lifetime[†] Shingles

The ultimate choice for a rugged wood-shake look, offering incredible depth and dimension.

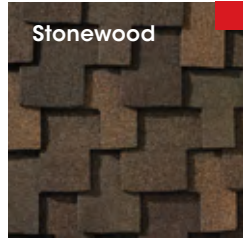
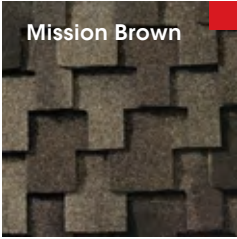

For more details visit gaf.com/GrandCanyon

Designer Lifetime[†] Shingles Collection LRS

NOTE: It is difficult to reproduce the color clarity and actual color blends of these products. Before selecting your color, please ask to see several full-size shingles.

GAF Grand Sequoia®
Designer Lifetime+ Shingles

Artisan-crafted shapes combined with oversized tabs result in a sophisticated beauty unmatched by typical shingles.



For more details visit gaf.com/GrandSequoia

GAF Camelot II®
Designer Lifetime+ Shingles

Designed to complement your home's exterior color scheme, these shingles give your home the luxury look you want without breaking your budget.



For more details visit gaf.com/CamelotII

GAF Woodland®
Designer Lifetime⁺ Shingles

The stylish look of hand-cut European shingles at an incredibly affordable price.



Castlewood Gray

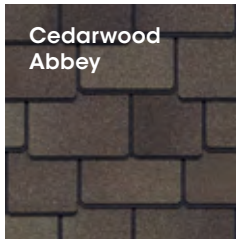

Cedarwood Abbey

For more details visit gaf.com/Woodland

GAF Slateline®
Designer Lifetime⁺ Shingles

Bold shadow lines and tapered cut-outs create the look of slate at a fraction of the cost.

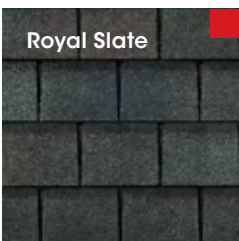

Royal Slate

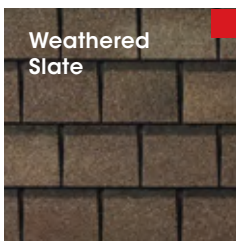

Weathered Slate

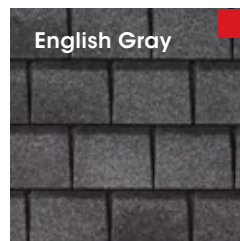

English Gray

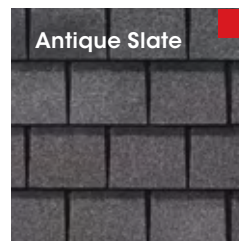

Antique Slate

For more details visit gaf.com/Slateline

NOTE: It is difficult to reproduce the color clarity and actual color blends of these products. Before selecting your color, please ask to see several full-size shingles.



SBS Modified Impact Resistance (IR) Shingles Collection

Engineered with SBS modified asphalt to really take a punch from Mother Nature.

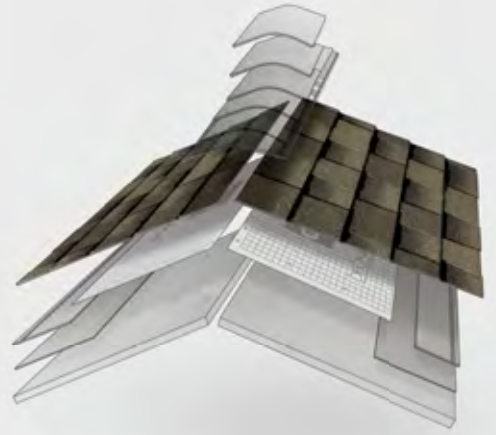

<p>Timberline® AS II</p> <p>pg 17</p>			<p>UL2218 Class 4 impact resistance to help protect your most valuable asset</p>
<p>Grand Sequoia® AS</p> <p>pg 17</p>			<p>The look of rugged wood shakes in an asphalt shingle with UL2218 Class 4 impact resistance</p>

For specifications see pages 20–21

UL 2218 Class 4 Impact-Resistance Test

A 2" steel ball is dropped twice from a 20' height onto various target locations to evaluate the shingles' ability to withstand the impact.

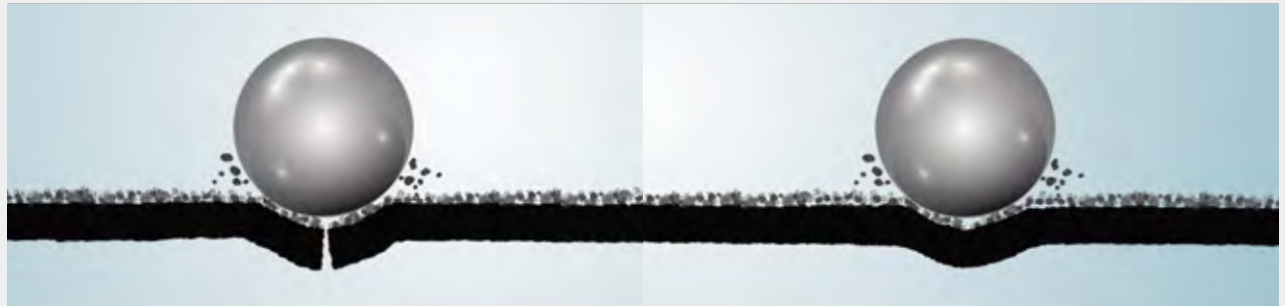

✘ Fail

✔ Pass

Result on a standard shingle

Evidence of visible ruptures or cracks through the shingle immediately after impact

Results on a Class 4 shingle

No evidence of ruptures or cracks through the shingle immediately after impact



For the full collection visit gaf.com/ArmorShield



¹ 15-year WindProven™ limited wind warranty on GAF Shingles with LayerLock® Technology requires the use of GAF Starter Strips, Roof Deck Protection, Ridge Cap Shingles, and Leak Barrier or Attic Ventilation. See GAF Roofing System Limited Warranty for complete coverage and restrictions. Visit gaf.com/LRS for qualifying GAF products. For installations not eligible for the GAF Roofing System Limited Warranty, see the GAF Shingle & Accessory Limited Warranty.

GAF **Timberline® ASII**
ArmorShield® II SBS-Modified IR Shingles

Crafted to pass the UL 2218 Class 4 impact resistance test, and capture the essence of wood in a thick asphalt design.

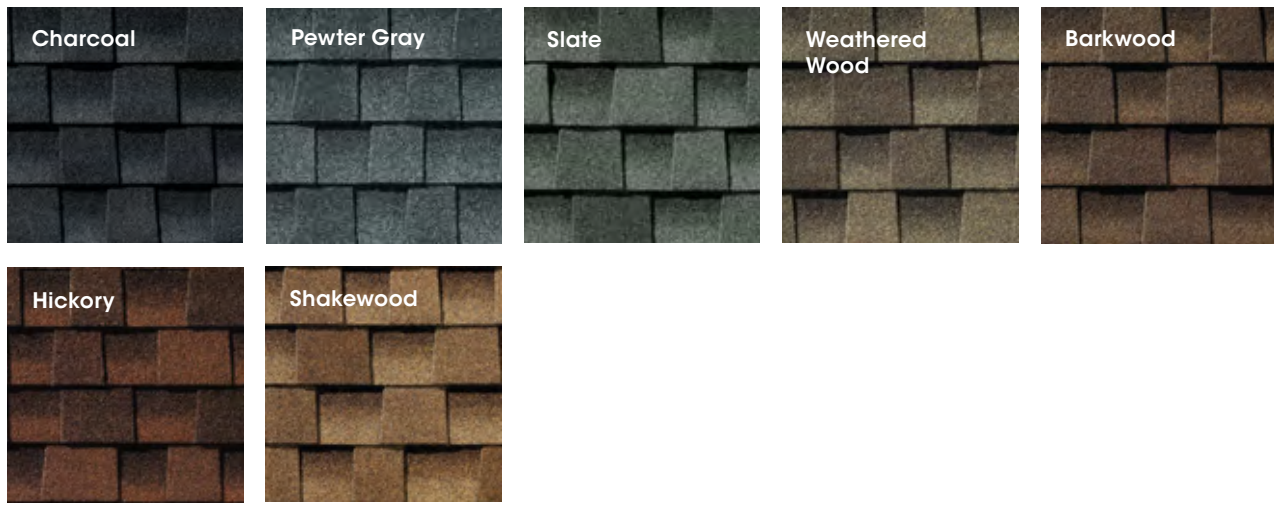

For more details visit gaf.com/AS

GAF **GrandSequoia® AS**
ArmorShield® SBS-Modified IR Shingles

A durable designer shingle with rugged wood-shake look that passes the UL 2218 Class 4 impact resistance test.



For more details visit gaf.com/GrandSequoiaAS

¹ 15-year WindProven™ limited wind warranty on GAF Shingles with LayerLock® Technology requires the use of GAF Starter Strips, Roof Deck Protection, Ridge Cap Shingles, and Leak Barrier or Attic Ventilation. See GAF Roofing System Limited Warranty for complete coverage and restrictions. Visit gaf.com/LRS for qualifying GAF products. For installations not eligible for the GAF Roofing System Limited Warranty, see the GAF Shingle & Accessory Limited Warranty.

NOTE: It is difficult to reproduce the color clarity and actual color blends of these products. Before selecting your color, please ask to see several full-size shingles.

3-Tab Shingles

The perfect choice for first-time buyers, these shingles add beauty and performance to any roof.

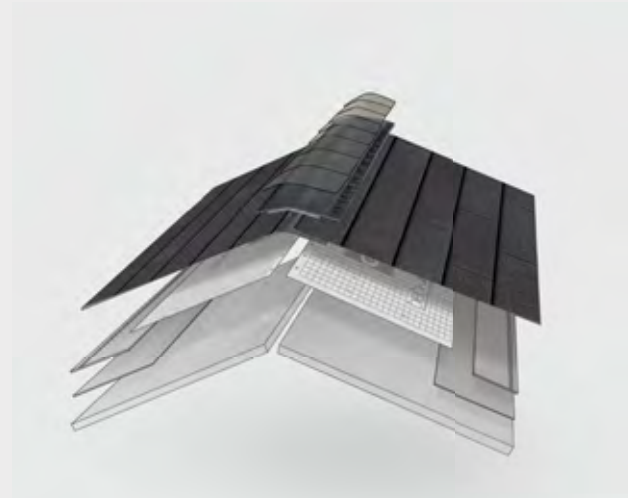

Royal Sovereign®
pg 18-19



Excellent performance and a vivid design make for an exceptional investment

For specifications see pages 20-21

Color Availability

Royal Sovereign®		1	2	3	4	5
Autumn Brown			•	•	•	•
Charcoal		•	•	•	•	•
Golden Cedar			•	•	•	•
Silver Lining			•			•
Weathered Gray			•	•	•	•
White ¹		•	•			•
Ash Brown				•		
Nickel Gray			•			
Slate			•	•	•	

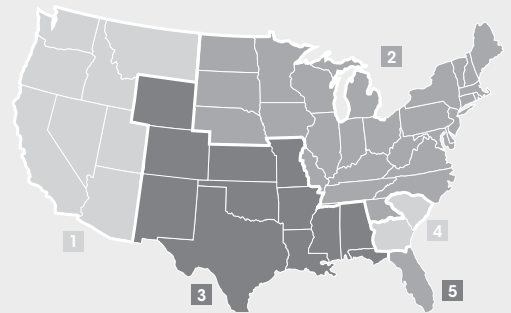

¹ Royal Sovereign® White can be used to comply with 2019 Title 24, Part 6, Cool Roof Requirements of the California Code of Regulations; is rated by the Cool Roof Rating Council (CRRC); and meets Green Building Standards Code of Los Angeles County for residential buildings.

3-Tab Shingles (Excluded from LRS)



For the full collection visit gaf.com/3Tab



GAF Royal Sovereign[®]

3-Tab Shingles

Beautiful. Reliable. Affordable.

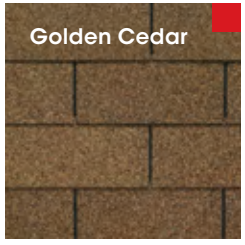
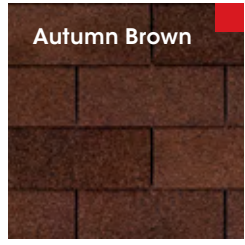
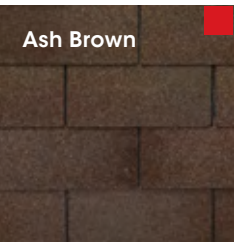
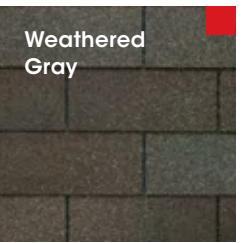
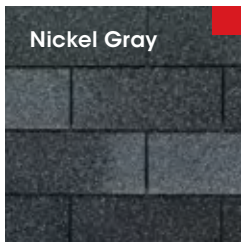
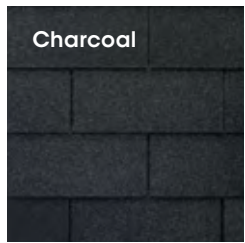

3-Tab Shingles (Excluded from LRS)

NOTE: It is difficult to reproduce the color clarity and actual color blends of these products. Before selecting your color, please ask to see several full-size shingles.

Shingle Specifications

Shingle	Warranty	Technology	Shingle Construction
Timberline® Lifetime[†] Shingles Collection			
Timberline HDZ®	†, 2, 4	, ,	
Timberline® UHDZ™	†, 2, 9	, , ,	
Timberline® NS	†, 3	,	
Timberline® CS	†, 2, 4	, , ,	
Designer Lifetime[†] Shingles Collection			
Grand Canyon®	†, 4	,	
Grand Sequoia®	†, 4	,	
Woodland®	†, 4	,	
Camelot® II	†, 4	,	
Slateline®	†, 4	,	
SBS Modified IR Shingles Collection			
Timberline® AS II	†, 2, 4	, , ,	
Grand Sequoia® AS	†, 4	, ,	
3-Tab Shingle			
Royal Sovereign®	1, 3	,	

[†] Lifetime refers to the length of warranty coverage provided and means as long as the original individual owner(s) of a single-family detached residence [or eligible second owner(s)] owns the property where the qualifying GAF products are installed. For other owners/structures, Lifetime coverage is not applicable. Lifetime coverage on shingles requires the use of GAF Lifetime Shingles only. See the *GAF Shingle & Accessory Limited Warranty* for complete coverage and restrictions. Visit gaf.com/LRS for qualifying GAF products. Lifetime coverage on shingles and accessories requires the use of any GAF Lifetime Shingle and at least 3 qualifying GAF Accessories. See the *GAF Roofing System Limited Warranty* for complete coverage and restrictions. For installations not eligible for the GAF Roofing System Limited Warranty, see the *GAF Shingle & Accessory Limited Warranty*. Visit gaf.com/LRS for qualifying GAF products.

¹ See *GAF Shingle & Accessory Limited Warranty* for complete coverage and restrictions.

² 15-year WindProven™ limited wind warranty on GAF Shingles with LayerLock® Technology requires the use of GAF Starter Strips, Roof Deck Protection, Ridge Cap Shingles, and Leak Barrier or Attic Ventilation. See *GAF Roofing System Limited Warranty* for complete coverage and restrictions. Visit gaf.com/LRS for qualifying GAF products. For installations not eligible for the *GAF Roofing System Limited Warranty*, see the *GAF Shingle & Accessory Limited Warranty*.

³ 10-year StainGuard® Algae Protection Limited Warranty against blue-green algae discoloration is available only on products sold in packages bearing the StainGuard® logo. See *GAF Shingle & Accessory Limited Warranty* for complete coverage and restrictions, and qualifying products.



Approximate Physical Attributes					Codes										Special Features		
					Fire	Wind		National				Regional					
Pieces/Square	Bundles/Square	Nails/Square ⁵	Exposure	Dimensions	UL Listed to ANSI/UL 790 Class A	ASTM D7158, Class H	ASTM D3161, Class F	ASTM D3018 Type 1	ASTM D3462 ⁶	Classified in accordance with ICC-ES AC438	Miami-Dade County Product Control Approved	State of Florida Approved	Texas Department of Insurance Listed	ICC-ES ESR-1475	ICC-ES ESR-3267	Passes UL 2218, Class 4 Impact Test	Cool Roof Rating Council (CRRCC) Rated

64	3	256	5 5/8" (143 mm)	13 1/4" x 39 3/8" (337 x 1,000 mm)	●	●	●	●	●	●	●	7	●	●	●	●	●	8
64	3	256	5 5/8" (143 mm)	13 1/4" x 39 3/8" (337 x 1,000 mm)	●	●	●	●	●	●	●	7	●	●	●	●	●	
64	3	256	5 5/8" (143 mm)	13 1/4" x 39 3/8" (337 x 1,000 mm)	●	●	●	●	●	●	●	7	●	●	●	●	●	
64	3	256	5 5/8" (143 mm)	13 1/4" x 39 3/8" (337 x 1,000 mm)	●	●	●	●	●	●	●	7	●	●	●	●	●	

72	6	360	5" (127 mm)	17" x 40" (432 x 1,016 mm)	●	●	●	●	●	●	●	●	●	●	●	●	●	
70	5	360	5" (127 mm)	17" x 40" (432 x 1,016 mm)	●	●	●	●	●	●	●	●	●	●	●	●	●	
56	4	280	6 1/2" (165 mm)	17" x 40" (432 x 1,016 mm)	●	●	●	●	●	●	●	●	●	●	●	●	●	
56	4	280	7 1/2" (191 mm)	17" x 34 1/2" (432 x 876 mm)	●	●	●	●	●	●	●	●	●	●	●	●	●	
48	3	288	7 1/2" (191 mm)	17" x 40" (432 x 1,016 mm)	●	●	●	●	●	●	●	●	●	●	●	●	●	

64	3	256	5 5/8" (143 mm)	13 1/4" x 39 3/8" (337 x 1,000 mm)	●	●	●	●	●	●	●	●	●	●	●	●	●	
72	4	360	5" (127 mm)	17" x 40" (432 x 1,016 mm)	●	●	●	●	●	●	●	●	●	●	●	●	●	

English 79	3	English 316	English 5" (127 mm)	English 12" x 36" (305 x 914 mm)	●	●	●	●	7	●	7	●	●	7	●	●	7
Metric 64		Metric 256	Metric 5 5/8" (143 mm)	Metric 13 1/4" x 39 3/8" (337 x 1,000 mm)													

⁴25-year StainGuard Plus™ Algae Protection Limited Warranty against blue-green algae discoloration is available only on products sold in packages bearing the StainGuard Plus™ logo. See GAF Shingle & Accessory Limited Warranty for complete coverage and restrictions, and qualifying products.

⁵Steeper slopes and maximum wind warranties may require more nails.

⁶Periodically tested by independent and internal labs to ensure compliance with ASTM D3462 at time of manufacture.

⁷Applies to some plants (that make referenced product).

⁸Applies to White only.

⁹30-year StainGuard Plus PRO™ Algae Protection Limited Warranty against blue-green algae discoloration is available only on products sold in packages bearing the StainGuard Plus PRO™ logo. See GAF Shingle & Accessory Limited Warranty for complete coverage and restrictions.







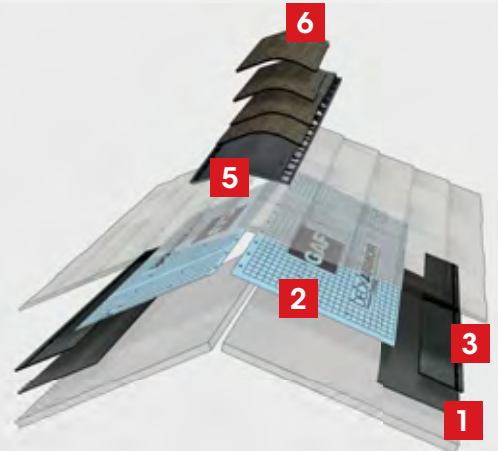





Roofing Accessories

Install any GAF Lifetime[†] Shingle and at least 3 qualifying GAF Accessories and you'll get a Lifetime[†] limited warranty on your qualifying GAF products.



Visit gaf.com/LRS for a list of qualifying products.

<p>Leak Barriers</p> <p>pg 23</p>			<p>Help prevent leaks caused by wind-driven rain and ice dams</p>
<p>Roof Deck Protection</p> <p>pg 24</p>			<p>Helps shield the roof deck from moisture infiltration</p>
<p>Starter Strip Shingles</p> <p>pg 25</p>			<p>Help guard against shingle blow-offs at the eaves and rakes</p>
<p>Cobra[®] Attic Ventilation</p> <p>pg 26</p>			<p>Helps reduce attic moisture and heat</p> <p>Also available, Master Flow[®] Ventilation Products, see page 28</p>
<p>Ridge Cap Shingles</p> <p>pg 27</p>			<p>The finishing touch that helps defend against leaks at the hips and ridges</p>

[†] Lifetime refers to the length of warranty coverage provided and means as long as the original individual owner(s) of a single-family detached residence [or eligible second owner(s)] owns the property where the qualifying GAF products are installed. For other owners/structures, Lifetime coverage is not applicable. Lifetime coverage on shingles requires the use of GAF Lifetime Shingles only. See the *GAF Shingle & Accessory Limited Warranty* for complete coverage and restrictions. Visit gaf.com/LRS for qualifying GAF products. Lifetime coverage on shingles and accessories requires the use of any GAF Lifetime Shingle and at least 3 qualifying GAF Accessories. See the *GAF Roofing System Limited Warranty* for complete coverage and restrictions. For installations not eligible for the *GAF Roofing System Limited Warranty*, see the *GAF Shingle & Accessory Limited Warranty*. Visit gaf.com/LRS for qualifying GAF products

[†] 15-year WindProven™ limited wind warranty on GAF Shingles with LayerLock® Technology requires the use of GAF Starter Strips, Roof Deck Protection, Ridge Cap Shingles, and Leak Barrier or Attic Ventilation. See *GAF Roofing System Limited Warranty* for complete coverage and restrictions. Visit gaf.com/LRS for qualifying GAF products. For installations not eligible for the *GAF Roofing System Limited Warranty*, see the *GAF Shingle & Accessory Limited Warranty*.



Leak Barriers

Help prevent leaks caused by wind-driven rain and ice dams.

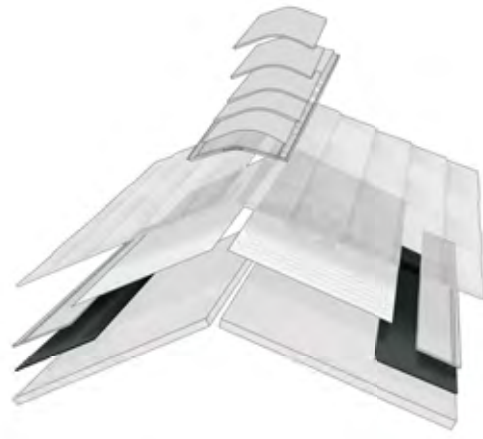

<p>StormGuard®</p>		<ul style="list-style-type: none"> ▪ Patterned synthetic film-surfaced peel and stick underlayment for asphalt shingles and metal roofing ▪ Self-seals fasteners and helps protect vulnerable areas of the roof ▪ 250°F high-temperature design. Meets or exceeds the performance criteria of ASTM D1970. ▪ 2 Sq. (200 ft² [18.58 m²]) roll size — excludes laps
<p>WeatherWatch®</p>		<ul style="list-style-type: none"> ▪ Mineral-surfaced peel and stick underlayment for asphalt shingles ▪ Self-seals fasteners and helps protect vulnerable areas of the roof ▪ Meets or exceeds the performance criteria of ASTM D1970 ▪ 2 Sq. (200 ft² [18.58 m²]) & 1.5 Sq. (150 ft² [13.94 m²]) roll sizes — excludes laps

Leak Barrier Application Recommendations:

Strongly recommended around	Optional around	Required by code at ¹	Region ¹
1. Penetrations	5. Hips & rake edges	7. Eaves in colder zones <i>Recommended in warmer zones</i>	1. Colder zone
2. Skylights	6. Ridges		2. Warmer zone
3. Valleys & dormers	4. Flashings & transitions		

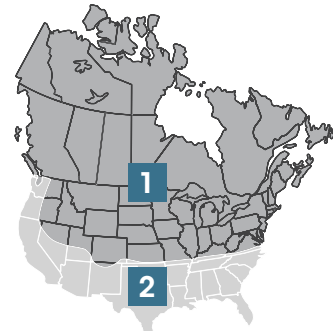
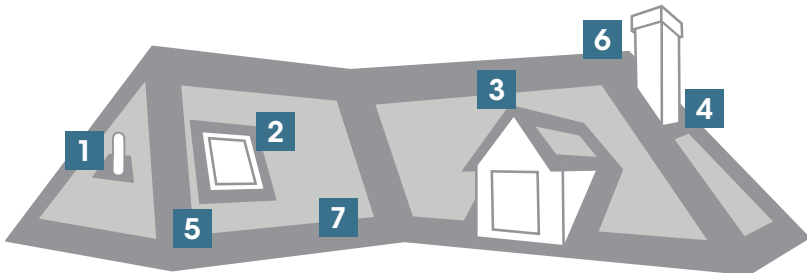

For the full collection visit gaf.com/LeakBarriers

¹ Always check local building codes for requirements in your area.

* To qualify for this coverage, must be installed with GAF Lifetime[®] Shingles and at least 3 qualifying GAF Accessories. See GAF.com/LRS for qualifying products and see GAF Roofing System Limited Warranty for complete coverage and restrictions.

Roof Deck Protection

Helps shield the roof deck from moisture infiltration.

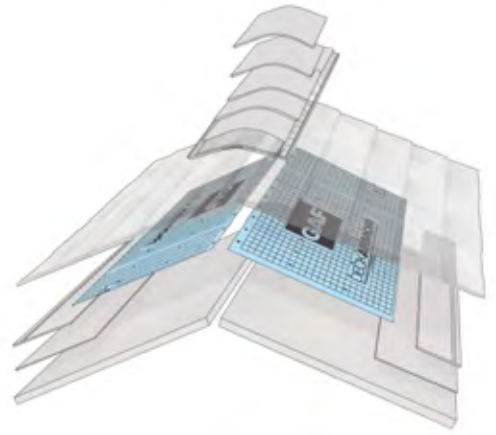

Deck-Armor™



- Premium breathable synthetic underlayment for asphalt shingles and other roof systems
- Nom. 16 perms, high-traction surface, and tear-resistant construction
- 48" x 250' (1.22 m x 76.2 m); 10 Sq. (1,000 ft² [92.9 m²]) roll size — excludes laps

Tiger Paw™



- Premium synthetic underlayment for asphalt shingles and other roof systems
- High-traction surface, tear-resistant construction, and deck side coating provides moisture control
- 48" x 250' (1.22 m x 76.2 m); 10 Sq. (1,000 ft² [92.9 m²]) roll size — excludes laps

FeltBuster®



- High-traction synthetic underlayment for asphalt shingles
- Value-priced, high-traction surface, and tear-resistant construction
- 48" x 250' (1.22 m x 76.2 m); 10 Sq. (1,000 ft² [92.9 m²]) roll size — excludes laps

Shingle-Mate™



- Fiberglass-reinforced underlayment for asphalt shingles
- Fiberglass reinforcement lays flat and helps prevent telegraphing through shingles
- 36" x 144' (.914 m x 43.89 m); 4 Sq. (432 ft² [40.13 m²]) roll size — excludes laps

Specialty Underlayment

VersaShield®

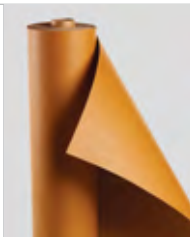

- Fiberglass-reinforced fire-resistant underlayment for asphalt shingles, metal, wood, and other roof systems
- Helps upgrade the UL Fire Rating of many roofing systems (always see the UL Certification Directory) and helps resist dangerous flame spread
- 42" x 100' (1.07 m x 30.48 m); 3.5 Sq. (350 ft² [32.5 m²]) roll size — excludes laps

For the full collection visit gaf.com/RoofDeckProtection

Starter Strip Shingles

Help guard against shingle blow-offs at the eaves and rakes.

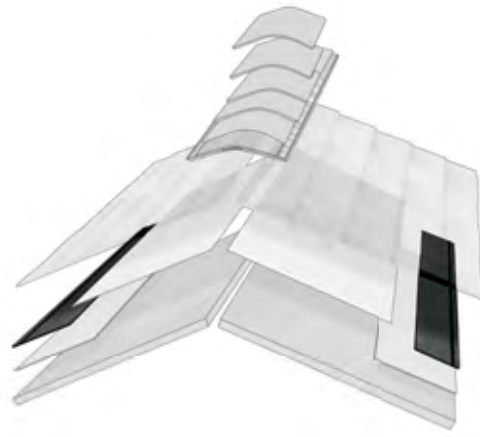

WeatherBlocker™		<ul style="list-style-type: none"> ▪ Premium starter strip shingles for all asphalt shingles ▪ Extra-wide format, pre-perforated design, and factory-applied Dura Grip™ Adhesive ▪ Full sheets measure 17" x 40" (432 mm x 1,016 mm) and cover 50 lin. ft. (15 lm) per bundle. Half sheets measure 8 ½" x 40" (216 mm x 1,016 mm) and cover 100 lin. ft. (30 lm) per bundle.
Pro-Start®		<ul style="list-style-type: none"> ▪ Starter strip shingles for most standard English and metric-sized asphalt shingles ▪ Pre-perforated design with factory-applied Dura Grip™ Adhesive ▪ Full sheets measure 13" x 38" (330 mm x 965 mm) and are split into half sheets measuring 6 ½" x 38" (165 x 965 mm) to cover 120.33 lin. ft. (36.69 lm) per bundle
QuickStart®		<ul style="list-style-type: none"> ▪ Peel and stick starter strip roll for most standard English and metric-sized asphalt shingles ▪ Mineral surfacing with factory-applied Dura Grip™ Adhesive ▪ 9" x 33' (228 mm x 10 m) roll size
StarterMatch®		<ul style="list-style-type: none"> ▪ Complementary-color starter strip shingles for Grand Sequoia® and Grand Canyon® Shingles ▪ 25-year StainGuard Plus™ Algae Protection™ Limited Warranty protects StarterMatch® Starter Strip Shingles from unsightly stains.¹ ▪ Used in conjunction with WeatherBlocker™ ▪ Full sheets measure 13 ¼" x 40" (337 mm x 1,016 mm) and cover 60 lin. ft. (18.3 lm) per bundle

For the full collection visit gaf.com/StarterStrip

* To qualify for this coverage, must be installed with GAF Lifetime! Shingles and at least 3 qualifying GAF Accessories. See GAF.com/LRS for qualifying products and see GAF Roofing System Limited Warranty for complete coverage and restrictions.

¹ 25-year StainGuard Plus™ Algae Protection Limited Warranty against blue-green algae discoloration is available only on products sold in packages bearing the StainGuard Plus™ logo. See GAF Shingle & Accessory Limited Warranty for complete coverage and restrictions, and qualifying products.

Cobra® Attic Ventilation

Helps reduce attic moisture and heat.¹

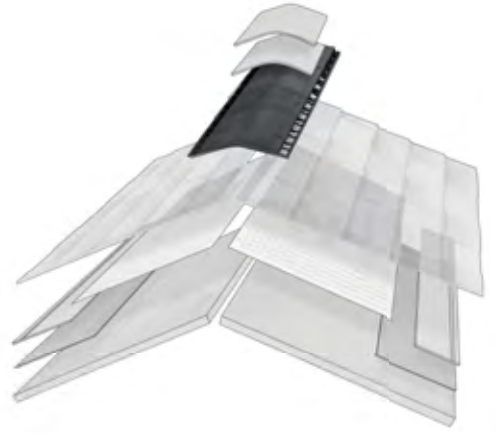

Ridge & Hip Exhaust Ventilation

<p>Cobra® Exhaust Vent</p>		<ul style="list-style-type: none"> ▪ Mesh roll ridge vent for all climates ▪ 10 ½" (267 mm), 8" (203 mm), and 11 ¾" (298 mm) widths; 20' (6.1 m) and 50' (15.24 m) lengths ▪ Includes 2 ½" (64 mm) Smart Nails™ (Hand Nailable) or 1 ¾" (44 mm) Coil Nails (Nail Gunnable) ▪ NFA: Hand Nailable — 16.9 sq. in./lin. ft. (35,772 mm² per lineal meter); Nail Gunnable — 14.1 sq. in./lin. ft. (29,845 mm² per lineal meter)
<p>Cobra® SnowCountry® Advanced</p>		<ul style="list-style-type: none"> ▪ Premium plastic ridge vent for colder climates ▪ Includes 3" (76 mm) ring shank nails, Snow Guard™ Filter & 3" (76 mm) EasyTear® Sizing ▪ 11 ½" (292 mm) and 9" (229 mm) widths; 4' (1.2 m) length, 40 lin. ft. (12.2 lm) per box ▪ NFA: 18 sq. in./lin. ft. (38,100 mm² per lineal meter)
<p>Cobra® SnowCountry®</p>		<ul style="list-style-type: none"> ▪ Plastic ridge vent for colder climates ▪ Includes Snow Guard™ Filter & 3" (76 mm) EasyTear® Sizing ▪ 11 ½" (292 mm) width; 4' (1.2 m) length, 40 lin. ft. (12.2 lm) per box ▪ NFA: 18 sq. in./lin. ft. (38,100 mm² per lineal meter)
<p>Cobra® Rigid Vent 3™</p>		<ul style="list-style-type: none"> ▪ Premium plastic ridge vent for warmer climates ▪ Includes 3" (76 mm) ring shank nails & 3" (76 mm) EasyTear® Sizing ▪ 11 ½" (292 mm) and 9" (229 mm) widths; 4' (1.2 m) length, 40 lin. ft. (12.2 lm) per box ▪ NFA: 18 sq. in./lin. ft. (38,100 mm² per lineal meter)
<p>Cobra® RidgeRunner®</p>		<ul style="list-style-type: none"> ▪ Plastic roll ridge vent for all climates ▪ Includes 1 ¾" (44 mm) coil nails, Weather Fighter® Filter & 12" (305 mm) EasyTear® Sizing ▪ 11 ½" (292 mm) width; 20' (6.1 m) length ▪ NFA: 12.5 sq. in./lin. ft. (26,458 mm² per lineal meter)
<p>Cobra® Hip Vent</p>		<ul style="list-style-type: none"> ▪ Plastic hip vent for all climates ▪ Includes 1 ¾" (44 mm) coil nails and Dual Weather Fighter® Filter ▪ 11 ½" (292 mm) width; 4' (1.2 m) length, 40 lin. ft. (12.2 lm) per box ▪ NFA: 9 sq. in./lin. ft. (19,050 mm² per lineal meter)
<p>Intake Ventilation</p>		
<p>Cobra IntakePro®</p>		<ul style="list-style-type: none"> ▪ Tapered roll intake vent for all climates ▪ Includes 1 ¾" (44 mm) coil nails and end cap fabric ▪ 11" (279 mm) width; 20' (6.1 m) length ▪ NFA: 9 sq. in./lin. ft. (19,050 mm² per lineal meter) 1. See photo for product placement

For more details visit gaf.com/Cobra

^{*} To qualify for this coverage, must be installed with GAF Lifetime® Shingles and at least 3 qualifying GAF Accessories. See GAF.com/LRS for qualifying products and see *GAF Roofing System Limited Warranty* for complete coverage and restrictions.

¹ **NOTE:** Always have a balanced attic ventilation system. In no case should the amount of exhaust ventilation at or near the ridge exceed the amount of intake ventilation at or near the soffit. Visit gaf.com/ventcalculator for more details.

Ridge Cap Shingles

The finishing touch that helps defend against leaks at the hips and ridges.



<p>TimberTex®</p>			<ul style="list-style-type: none"> ▪ Premium double-layer ridge cap shingles for use with Timberline HDZ®, Timberline® NS, UHDZ™, and GAF Designer Lifetime† Shingles ▪ Pre-perforated design & factory-applied Dura Grip™ Adhesive ▪ 12" (305 mm) width, 8" (203 mm) exposure, covers 20 lin. ft. (6.1 lm) per bundle ▪ Available in all areas (except West area)
<p>Seal-A-Ridge®</p>			<ul style="list-style-type: none"> ▪ Traditional look ridge cap shingles for use with Timberline HDZ®, Timberline® NS, UHDZ™, and CS Shingles ▪ Pre-perforated design & factory-applied Dura Grip™ Adhesive ▪ 12" (305 mm) width, 6 2/3" (169 mm) exposure, covers 25 lin. ft. (7.6 lm) per bundle ▪ Available in all areas
<p>TimberCrest®</p>			<ul style="list-style-type: none"> ▪ Premium SBS-modified bullnose ridge cap shingles for use with Timberline HDZ®, Timberline® NS, UHDZ™, RS/RS+, CS, and GAF Designer Lifetime† Shingles ▪ Pre-folded/flexed design & factory-applied Dura Grip™ Adhesive ▪ 10" (254 mm) width, 8" (203 mm) exposure, covers 20 lin. ft. (6.1 lm) per box ▪ Available in the West area
<p>Ridglass®</p>			<ul style="list-style-type: none"> ▪ High-profile SBS-modified ridge cap shingles for use with Timberline HDZ®, Timberline® NS, RS/RS+, and UHDZ™ Shingles ▪ Pre-folded design & factory-applied Dura Grip™ Adhesive ▪ 10" (254 mm) width, 8" (203 mm) exposure, covers 31 lin. ft. (9.4 lm) per box ▪ Available in the West area
<p>Z®Ridge</p>			<ul style="list-style-type: none"> ▪ Wood shake-look ridge cap shingles for use with Timberline HDZ®, Timberline® NS, and UHDZ™ Shingles ▪ Pre-perforated design with unique Z-fold design ▪ 10" (254 mm) width, 5 5/8" (143 mm) exposure, covers 33.3 lin. ft. (10.1 lm) per bundle ▪ Available in the Southwest and West areas
<p>Seal-A-Ridge® AS</p>			<ul style="list-style-type: none"> ▪ UL Class 4 impact resistance, pre-perforated design & factory-applied Dura Grip™ Adhesive ▪ For use with GAF ArmorShield® Series Shingles ▪ 12" (305 mm) width, 5" (127 mm) exposure, covers 25 lin. ft. (7.6 lm) per bundle

For more details visit gaf.com/RidgeCaps

* To qualify for this coverage, must be installed with GAF Lifetime† Shingles and at least 3 qualifying GAF Accessories. See GAF.com/LRS for qualifying products and see GAF Roofing System Limited Warranty for complete coverage and restrictions.

NOTE: These products are not available in all areas. Visit gaf.com/ridgecapavailability for more information.















GAF MasterFlow®

Ventilation Products

Ventilation products that help minimize heat and moisture in attics, while helping to resist mold and mildew.



<p>Power attic vents — roof mount</p>	<p>1</p> 	<p>2</p>  	<ul style="list-style-type: none"> ▪ Exhaust large amounts of heat and moisture from the attic ▪ Hardwired electric or EZ Cool™ Plug-in options ▪ High-efficiency PSC motors ▪ Thermostat control included on all models. Optional combo humidistat/thermostat control available on select models. ▪ Available with optional QuickConnect™ Wi-Fi Technology ▪ Available in popular colors to complement most finished roofs
<p>Solar-powered vents</p>	<p>2</p> 	<p>2</p> 	<ul style="list-style-type: none"> ▪ Helps reduce electricity costs associated with operating a fully electric powered vent¹ ▪ Available in both solar-powered and unique dual-powered models ▪ Solar-powered models run off the sun's power, while dual-powered models switch automatically between sun and house power ▪ Thermostat or combo humidistat/thermostat control available on select models
<p>Roof louvers</p>	<p>3</p> 	<p>2</p> 	<ul style="list-style-type: none"> ▪ Allow heat and moisture to escape the attic on roofs with limited ridge ▪ Styles: slant-back, square-top, dome ▪ Construction: aluminum, galvanized, and plastic. Models with optional weather filter also available ▪ Net Free Area per Vent: Options from 37–144 sq. in. (23,871–92,903 mm²)
<p>Aluminum ridge vent</p>		<p>2</p> 	<ul style="list-style-type: none"> ▪ Allows heat and moisture to escape the attic ▪ Construction: aluminum with built-in baffle ▪ Net Free Area: 21.5 Sq. in. per lin. ft. (45,508 mm² per lineal meter)
<p>Wind turbines</p>		<p>2</p> 	<ul style="list-style-type: none"> ▪ Use wind power to pull heat and moisture from the attic ▪ Sizes: 12" (305 mm) and 14" (356 mm) ▪ Construction: aluminum internally braced, galvanized internally or externally braced
<p>Soffit/undereave intake vents</p>			<ul style="list-style-type: none"> ▪ Allow cooler dry air to enter the attic ▪ Styles: continuous, oval, rectangular, EmberShield® closeable ▪ Net Free Area per Vent: Options from 22–68 Sq. in (14,194–43,871 mm²)
<p>Other vents and accessories</p>	<p>4</p> 		<p>Also available: Master Flow® Versa Caps, Gable Wall Louvers, Goose Neck Vents, Vent Caps, Chimney Caps, Zinc Strips, Whole House Fans, and Foundation Vents</p>

For the full collection visit gaf.com/MasterFlow

¹ Energy cost savings are not guaranteed and the amount of savings may vary based on climate zone, utility rates, radiative properties of roofing products, insulation levels, HVAC equipment efficiency, and other factors.

² While Master Flow® Attic Exhaust Ventilation Products are covered separately by the Master Flow® Powered Ventilation Products Limited Warranty or Master Flow® Ventilation Products Limited Warranty, depending on product, they do count as an eligible qualifying accessory product in the GAF Attic Ventilation category of the WindProven™ Limited Wind Warranty. See gaf.com/LRS for eligible products.

NOTE: Always have a balanced attic ventilation system. In no case should the amount of exhaust ventilation at or near the ridge exceed the amount of intake ventilation at or near the soffit. Visit gaf.com/ventcalculator for more details.



The one and only solution for replacing old asbestos siding.

Siding — contains NO asbestos¹

<p>Purity™ Shingle</p>		<p>Textured surface with straight, wavy, or thatched edge</p>	<ul style="list-style-type: none"> ▪ Size: 12" x 24" (305 mm x 609 mm) ▪ Exposure: Straight and Wavy 11" (279 mm), Thatched 10 ½" (267 mm)
<p>Profile Shingle</p>		<p>Striated surface with straight edge</p>	<ul style="list-style-type: none"> ▪ Size: 9" x 32" (227 mm x 813 mm) ▪ Exposure: 8" (203 mm) ▪ Size: 12" x 24" (305 mm x 609 mm) ▪ Exposure: 11" (279 mm) ▪ Size: 14 5/8" x 32" (371 mm x 813 mm) ▪ Exposure: 13 5/8" (346 mm)
<p>Emphasis™ Shingle</p>		<p>Extra-thick wood grain look surface with thatched edge</p>	<ul style="list-style-type: none"> ▪ Size: 14 5/8" x 25 5/32" (371 mm x 639 mm) ▪ Exposure: 13" (330 mm)

Accessories

<p>Siding Backer Strips</p>		<p>Help protect the vertical seams between each piece of siding against weather infiltration</p>	<ul style="list-style-type: none"> ▪ 9" (227 mm) ▪ 12" (305 mm) ▪ 14" (357 mm)
<p>Hot-dipped Galvanized Siding Nails</p>		<p>Help provide maximum holding power and an excellent finished look</p>	<ul style="list-style-type: none"> ▪ White, ring shank nails ▪ 1 ¾" (44 mm)
<p>Pre-primed Individual Corners</p>		<p>Complete the outside corners of your WeatherSide™ Siding job</p>	<ul style="list-style-type: none"> ▪ 9" (227 mm) ▪ 12" (305 mm) ▪ 14" (357 mm) ▪ Emphasis™ corners

Visit gaf.com/WeatherSide

¹We recommend that any removal and disposal of asbestos-containing products be done by a professionally trained asbestos removal contractor.

Help reduce heat drive into conditioned/living spaces, and ventilated options exhaust excess moisture to reduce the risk of condensation in the roofing system.¹



Ventilated Roof Insulation Panels

<p>ThermaCal[®] 1</p>		<ul style="list-style-type: none"> ▪ For asphalt shingle and metal roof systems ▪ Nominal 4' x 8' (1.21 m x 2.44 m) panels with single layer of sheathing (7/16" OSB [11.1 mm] standard); other options available ▪ Includes air space and tongue-and-groove polyiso foam to reduce heat loss through panel joints ▪ Pre-spaced sheathing eliminates the need for H-clips and allows for sheathing expansion
<p>ThermaCal[®] 2</p>		<ul style="list-style-type: none"> ▪ For slate, tile, and maximum loading roof systems ▪ Nominal 4' x 8' (1.21 m x 2.44 m) panels with two layers of sheathing (7/16" OSB [11.1 mm] standard); other options available ▪ Includes air space and tongue-and-groove polyiso foam to reduce heat loss through panel joints ▪ Pre-spaced sheathing eliminates the need for H-clips and allows for sheathing expansion

Non-Ventilated Roof Insulation Panels

<p>ThermaCal[®]</p>		<ul style="list-style-type: none"> ▪ For metal roof systems ▪ Nominal 4' x 8' (1.21 m x 2.44 m) panels with single layer of sheathing (7/16" OSB [11.1 mm] standard); other options available ▪ Tongue-and-groove polyiso foam to reduce heat loss through panel joints ▪ Pre-spaced sheathing eliminates the need for H-clips and allows for sheathing expansion
-------------------------------------	--	---

Exterior Wall Insulation Panels

<p>ThermaCal[®] Wall</p>		<ul style="list-style-type: none"> ▪ Nominal 4' x 8' (1.21 m x 2.44 m) panels with one layer of sheathing (7/16" OSB [11.1 mm] standard); other options available ▪ Includes tongue-and-groove polyiso foam (8' [2.44 m] sides only) to reduce heat loss through panel joints ▪ Pre-spaced sheathing (8' [2.44 m] sides) allows for precision fit and sheathing expansion
--	--	--

Nail Base Insulation Panel Fasteners

<p>ThermaCal[®] Light-duty drill point fasteners</p>		<ul style="list-style-type: none"> ▪ Designed for attaching ThermaCal[®] Insulation Panels to steel roof decks/substrates ▪ Manufactured with case-hardened and tempered carbon steel
<p>ThermaCal[®] Thread point fasteners</p>		<ul style="list-style-type: none"> ▪ Designed for attaching ThermaCal[®] Insulation Panels to wood roof decks/substrates ▪ Manufactured with case-hardened and tempered carbon steel

For the full collection visit gaf.com/ThermaCal

GAF **LIBERTY™**
SBS Self-Adhering Roofing System



Granulated self-adhering low-slope roofing system. Installs quickly and easily without the hassles of bulky equipment, unpleasant odors, torches, or open flames on your roof. Perfect for porches, garages, car ports, and sunrooms!

<p>LIBERTY™ Premium SBS Flashing Cement</p>		<ul style="list-style-type: none"> ▪ 1 Gallon (3.79L) ▪ Meets or exceeds ASTM D4586, Type 1 ▪ Meets or exceeds ASTM D3409
<p>LIBERTY™ Asphalt Primer</p>		<ul style="list-style-type: none"> ▪ 1 Gallon (3.79L) ▪ Meets or exceeds ASTM D41
<p>LIBERTY™ SBS Self-Adhering Base/Ply Sheet</p>		<ul style="list-style-type: none"> ▪ 2 square (216 sq. ft. [20.1 m²]) roll size - excludes laps ▪ Meets or exceeds ASTM D4601, Type II and ASTM D1970
<p>LIBERTY™ SBS Self-Adhering Cap Sheet</p>		<ul style="list-style-type: none"> ▪ 1 square (112 sq. ft. [10.4 m²]) roll size - excludes laps ▪ Meets or exceeds ASTM D6164, Type I

LIBERTY™ Cap Sheet Colors¹:



For the full collection visit gaf.com/Liberty

¹ These blended colors are designed to complement your shingles, not to be an exact match. Because of the small size of these samples, it's difficult to reproduce the actual color effect. Please be sure to see a full-size roll before making a final color selection or installing on the roof.

Go beyond for your customers and your business



GAF Timberline® UHDZ™
Ultra High Definition® Shingles



Timberline® UHDZ™ is now our premium laminate shingle

Featuring our patent-pending Dual Shadow Line, LayerLock® Technology and the StrikeZone® Nailing Area, 20% heavier weight, new 30-year StainGuard Plus PRO™¹ limited warranty against blue-green algae discoloration, and the opportunity for Master Elite® contractors to offer 30 years of workmanship coverage, Timberline® UHDZ™ shingles go beyond any GAF shingle you've been able to offer to date. Visit gaf.com/uhdz

